

FIG. 1

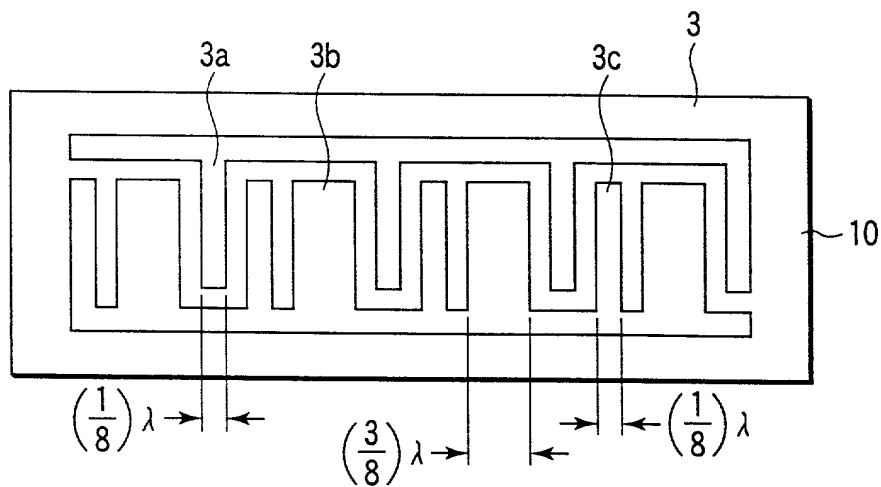

FIG. 2

TOP SECRET

RESONANCE FREQUENCY	F11	F12	Fc2	Fc1	Fu1	Fu2
PHASE RELATIONSHIP (SIGN)	+	-	+	-	+	-

FIG. 3

RESONANCE FREQUENCY	F11	F12	Fc2	Fc1	Fu1	Fu2
PHASE RELATIONSHIP (SIGN)	-	+	-	+	-	+

FIG. 4

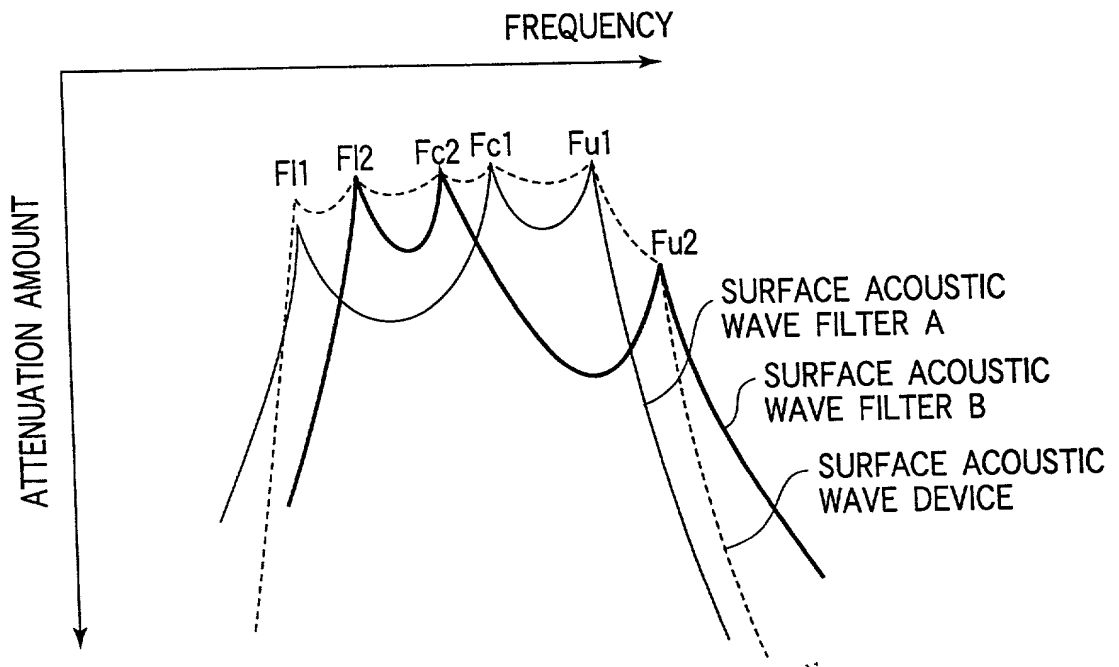

FIG. 5

2025 RELEASE UNDER E.O. 14176

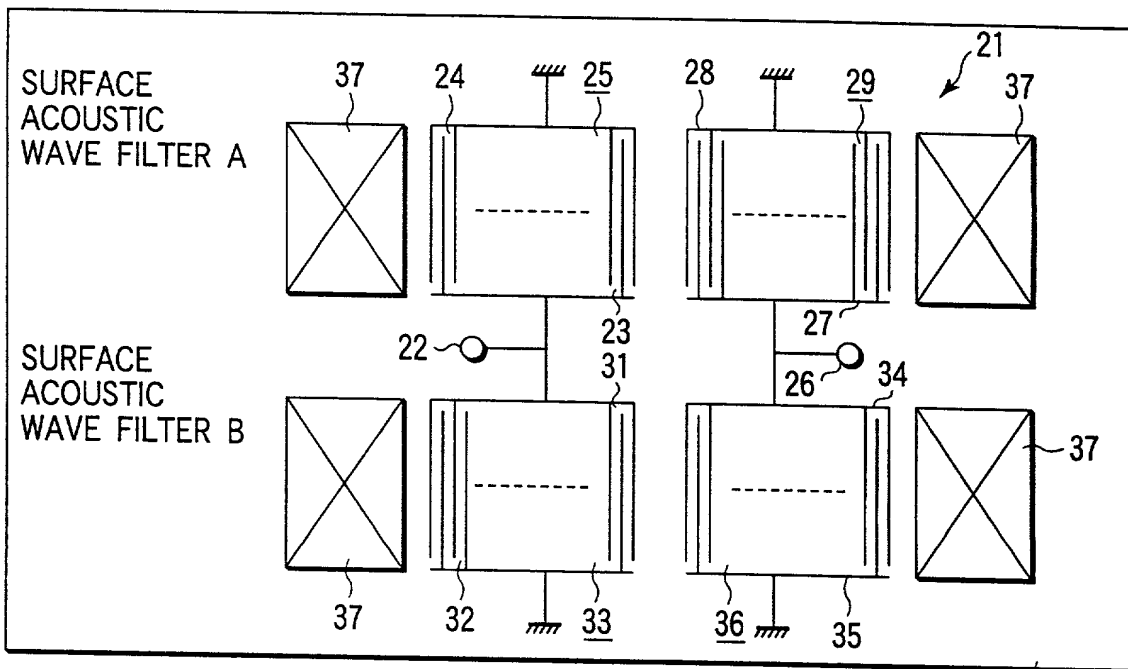

FIG. 6

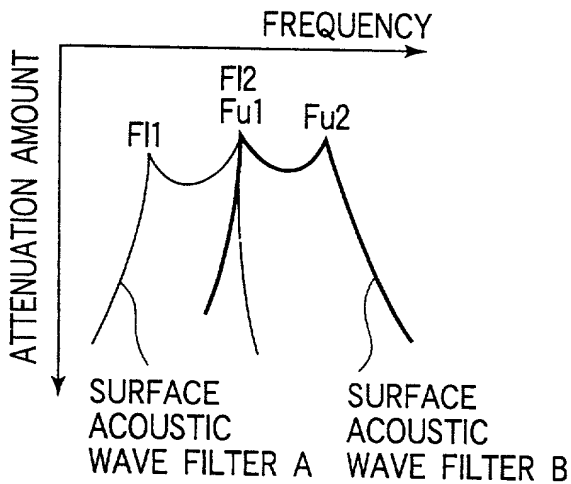

FIG. 7

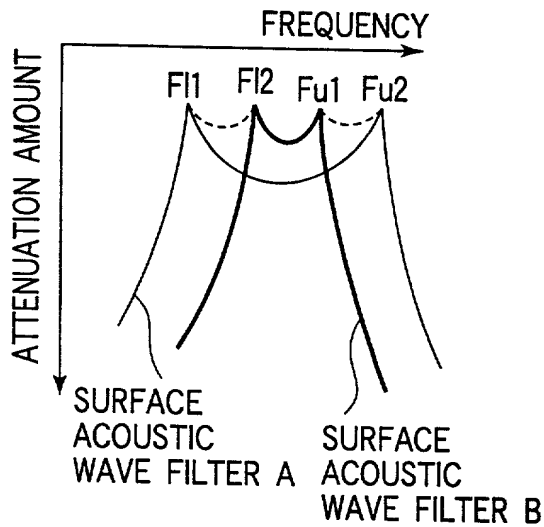

FIG. 8

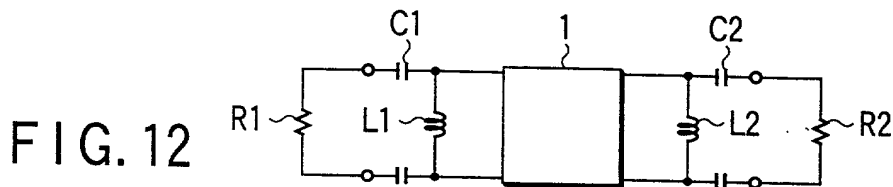

FIG. 12

FOUO "EST 660

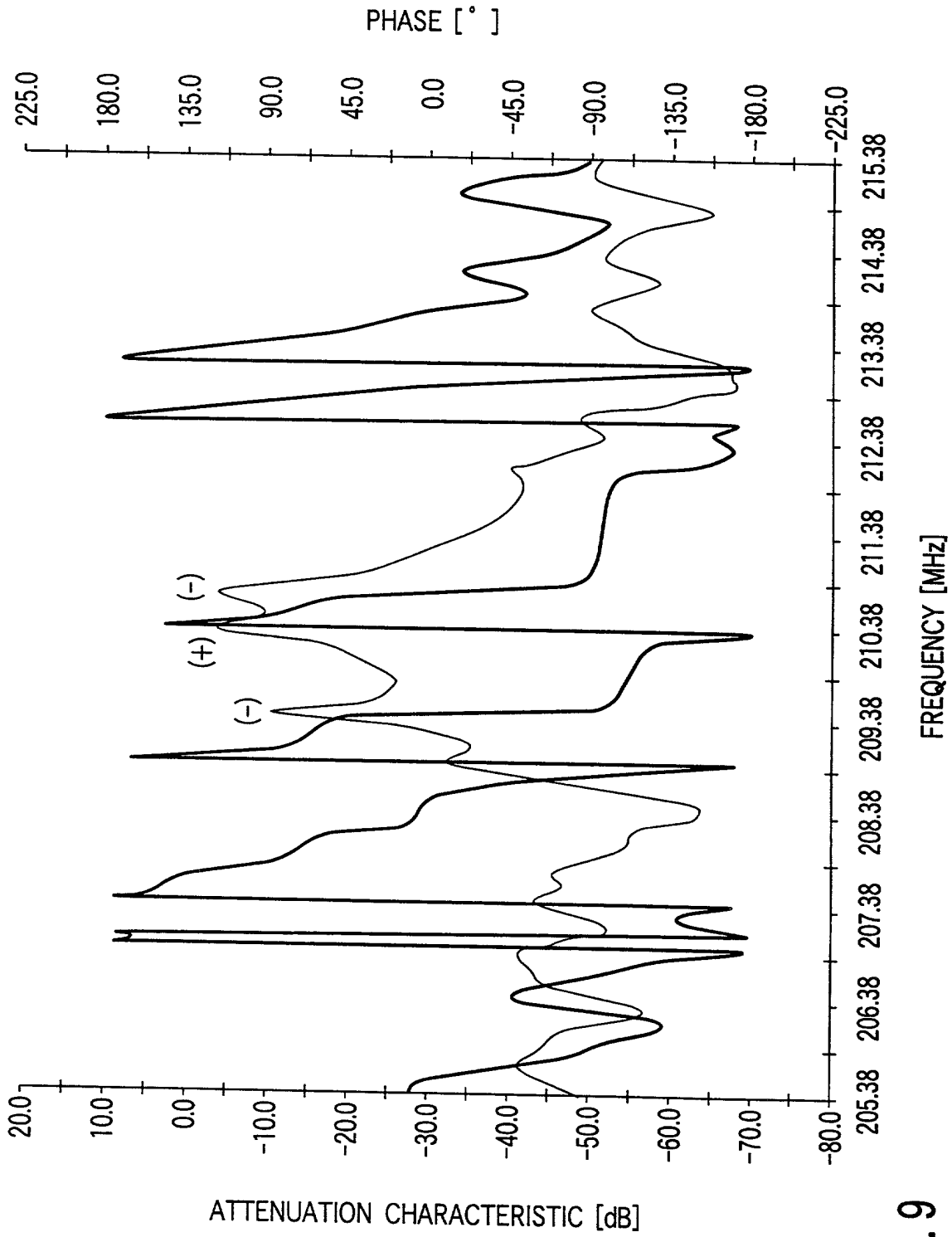

FIG. 9

20250806 09:00:00

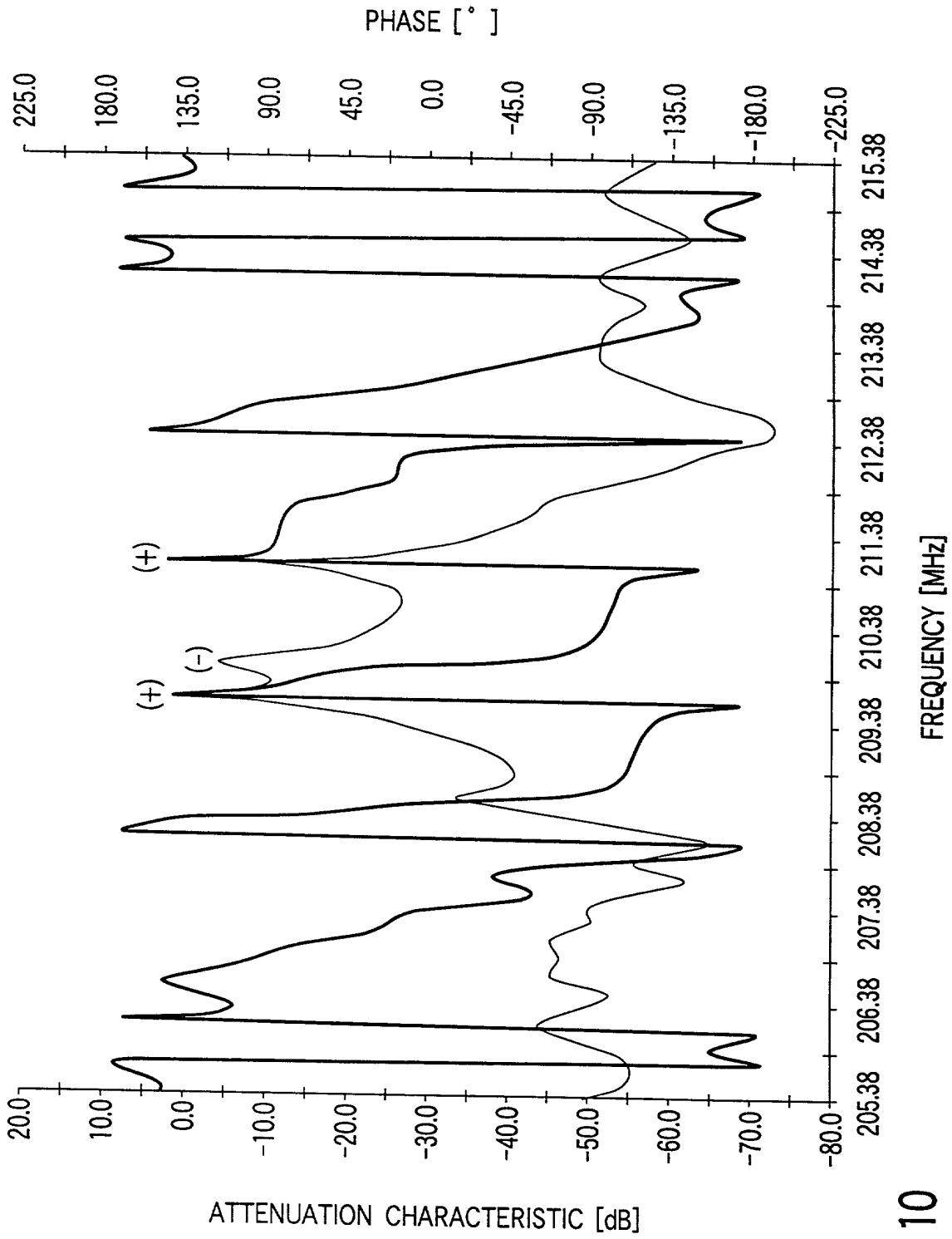

FIG. 10

2025 RELEASE

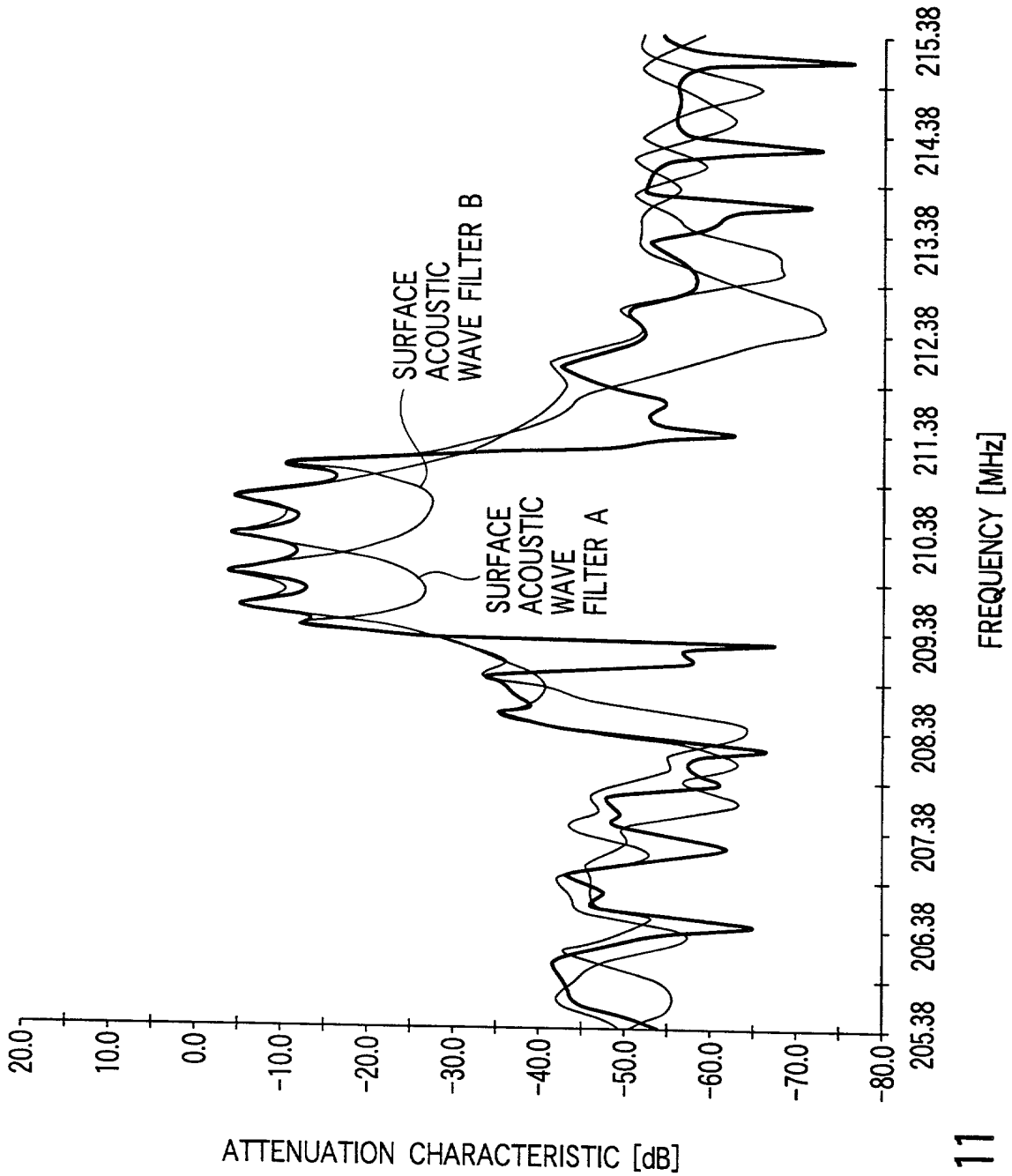

FIG.11

201090 88676860

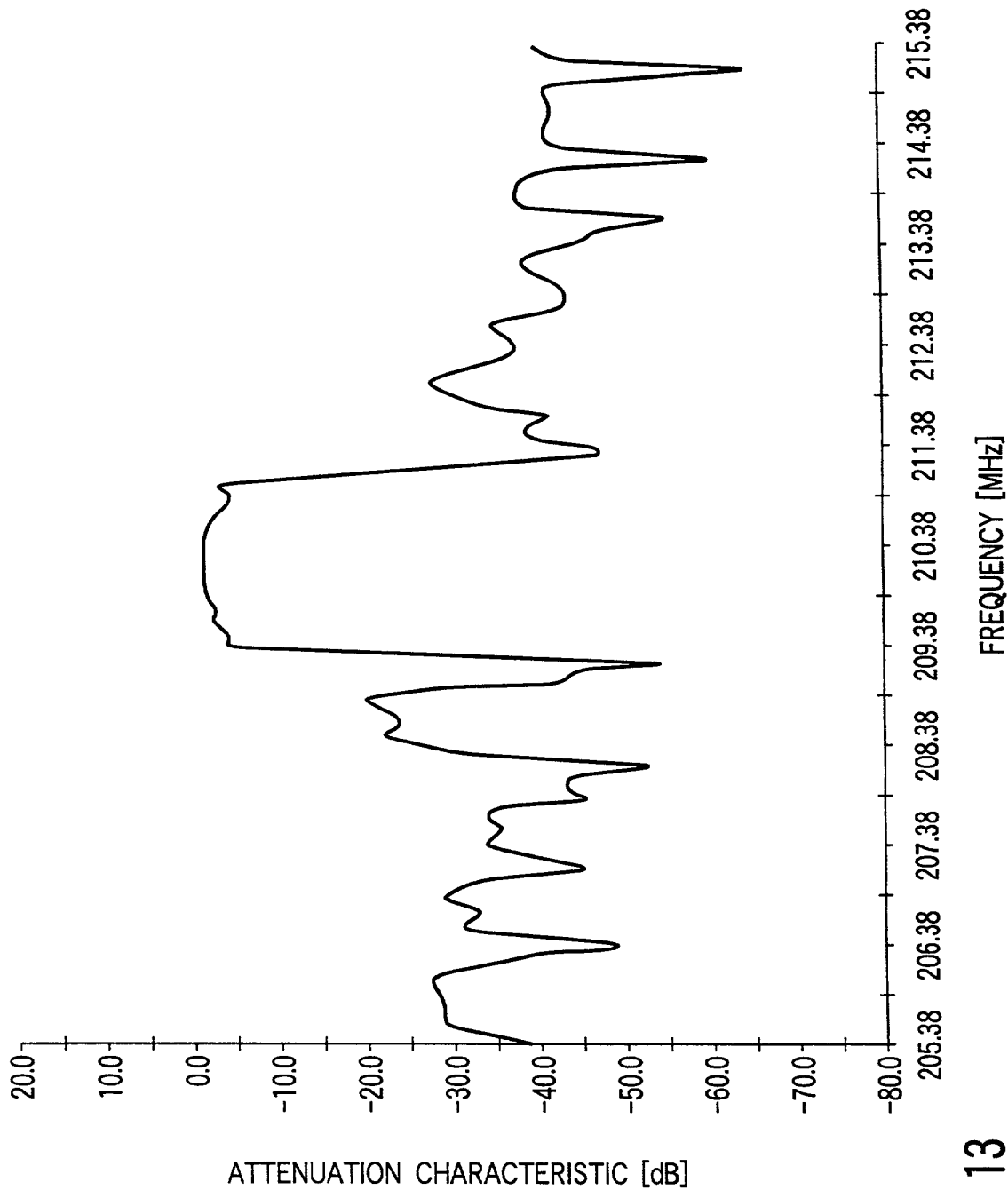

FIG. 13

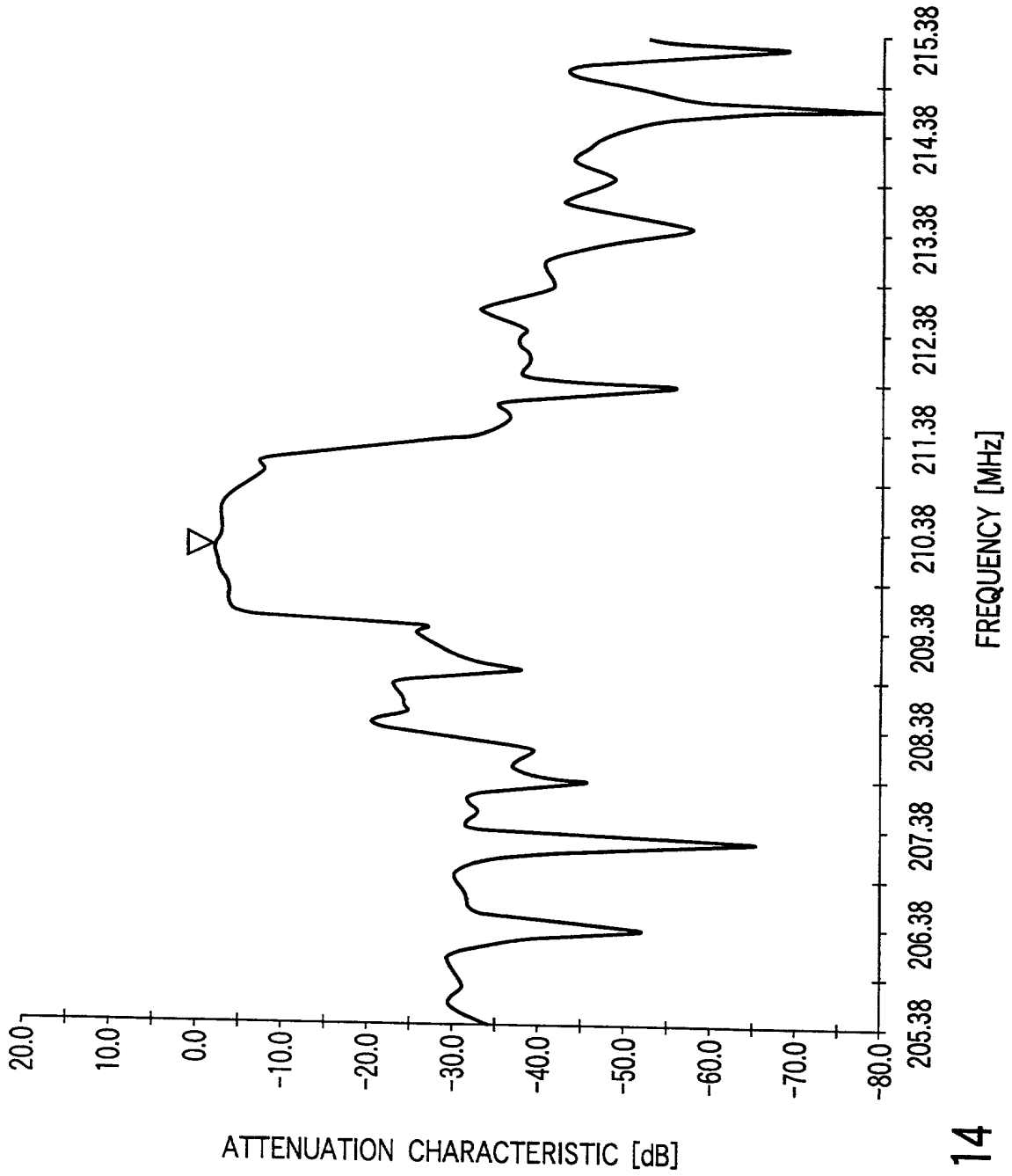

FIG. 14

20250806 08:00:00